

IQ System Controller 2

Quick Install Guide



MODEL NUMBER-
EP200G101-M240US01

VERSION 8.0
OCTOBER 2022

The Enphase Energy System includes the Enphase IQ System Controller 2 with Microgrid Interconnection Device (MID) capability, which consolidates interconnection equipment into a single enclosure and streamlines grid-independent capabilities of PV and storage installations by providing a consistent, pre-wired solution for residential applications. Along with MID functions, it includes PV, storage, and generator input circuits.

To install the Enphase IQ System Controller 2 and the Enphase IQ System Controller 2 wall-mount bracket, read and follow all warnings and instructions in this guide and in the **Enphase IQ System Controller 2 Installation and Operation Manual** at enphase.com/support.

Safety warnings are listed on the back of this guide. These instructions are not meant to be a complete explanation of how to design and install an energy storage system. All installations must comply with national and local electrical codes and standards. Only qualified electricians shall install, troubleshoot, or replace the IQ System Controller 2.



Table of contents

Scenario 1

Whole home back-up with IQ System Controller 2

Scenario 2

Partial home back-up with IQ System Controller 2

Scenario 2A

Partial home backup with Sunlight Backup

What's in the box

Tools / Additional items required

Section A

Mounting the product

Plan a location for the IQ System Controller 2

Step 1: Minimum clearance

Step 2: Installing the mounting bracket

Step 3: Open the deadfront

Section B

Mounting the breakers

Internal schematic of IQ System Controller 2

Wiring for service entrance

Install main and back-up breakers

Installing DER breakers for IQ8 Systems without Generator

Installing DER breakers for IQ8 Systems with Generator

Installing DER breakers for non IQ8 Systems

Section C

Wiring

Drill conduits

DER wiring

Aux wiring: Rapid shutdown switch

Aux wiring: IQ Load Controller

Aux wiring: Generator control

Mains / Supply side wiring

Back-up loads wiring

CT wiring

Close and energize IQ System Controller 2

Safety

Scenario 1

Whole home back-up with IQ System Controller 2

This is the preferred configuration for back up of the entire main load panel. This configuration supports up to an 80A breaker each for the PV circuit, battery storage and Generator(optional).

The microinverters ranges supported in this configuration are IQ8, IQ6/7, M-Series and S-Series.

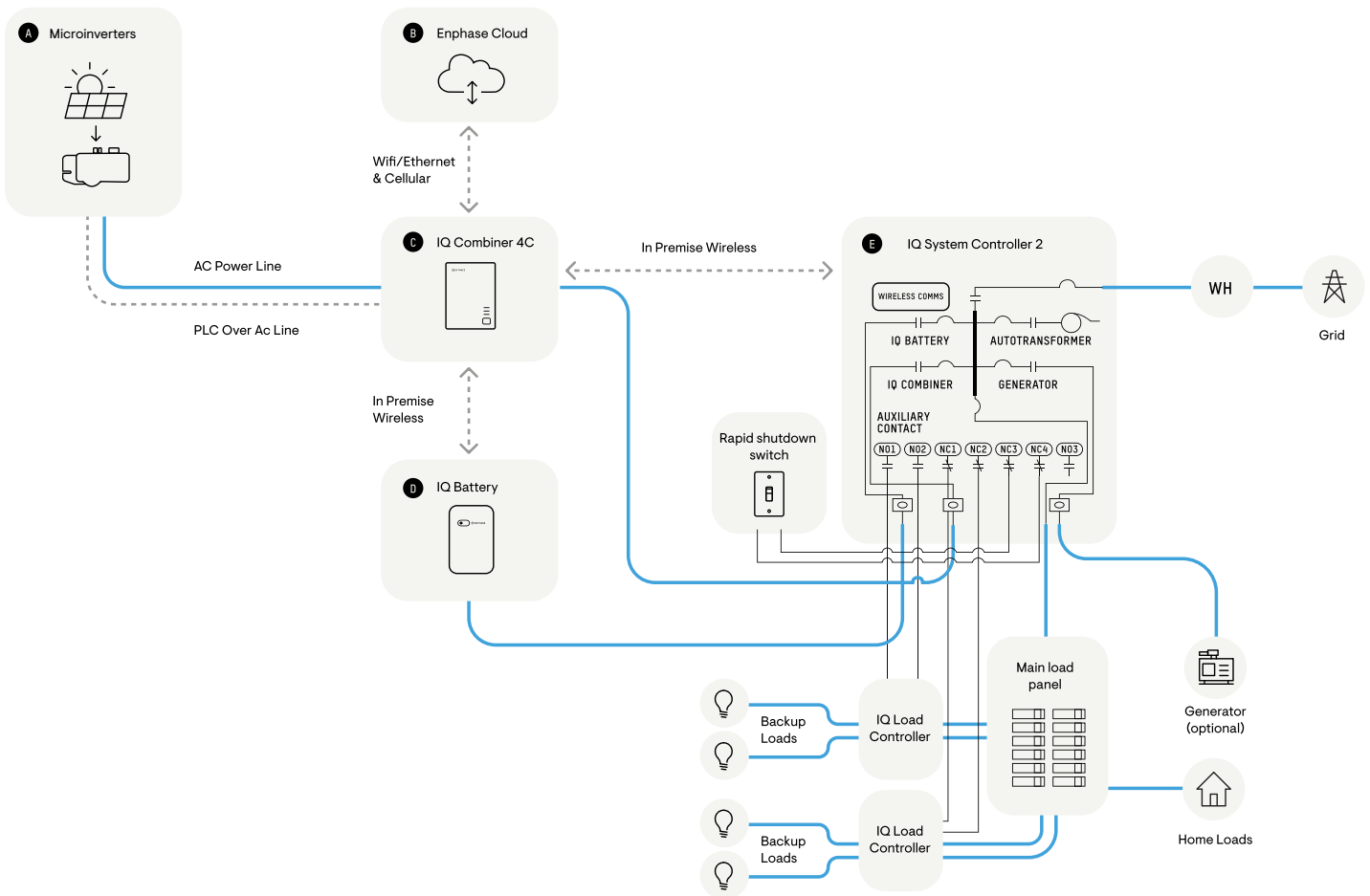

Scenario 2A

Partial home backup with Sunlight Backup

This is the preferred configuration for partial home backup with subpanel using only IQ8 PV. Generator can be integrated with IQ System Controller 2 based on the homeowner's needs.

It is recommended that installers use 2 IQ Load Controllers in order to do load shedding to ensure seamless back up of essential loads using IQ8 Microinverters.

It is not recommended to install sunlight back up for whole home back up scenarios.

This configuration can be supported with only IQ8 Microinverters.

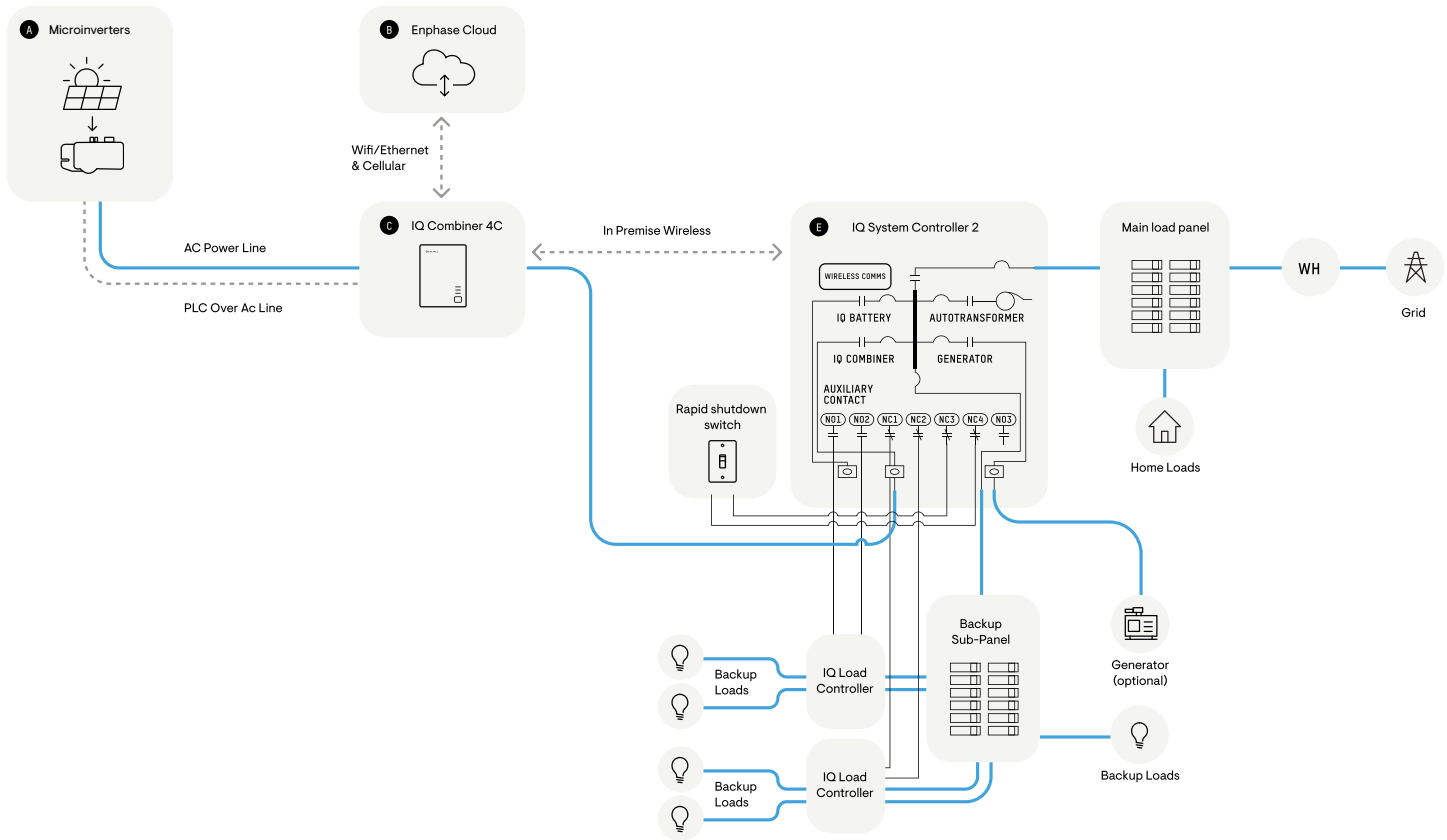

What's in the box

IQ System Controller 2

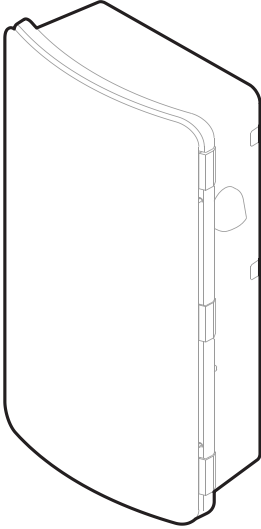

Wall Mounting Bracket

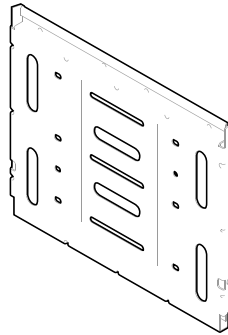

Rapid Shutdown Switch

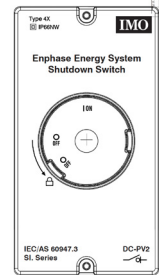

Accessory kit

ITEM NAME	ITEM CATEGORY PATH	DESCRIPTION	QUANTITY
Filler Cover Mounting BKT-L 200G Enpower	Plastic Part	Filler Cover Mounting BKT-L 200G IQ System Controller	2
Filler Cover Mounting BKT-R 200G Enpower	Plastic Part	Filler Cover Mounting BKT-R 200G IQ System Controller	2
Screw, Pan Hd , Phillips #3, M6x25mm Lg (5mm Shank - 20mm Thread), Machine, 304 SS	Fastener	Screw, Pan Hd , Phillips #3, M6x25mm Lg (5mm Shank - 20mm Thread), Machine, 304 SS	2
Screw, pan Hd, Torx X20, Machine, #8-32 UNC, 0.63" Lg, A2-70	Fastener	Screw, pan Hd, Torx X20, Machine, #8-32 UNC, 0.63" Lg, A2-70	1
Lit Kit Label, Enpower 200G	Label	Lit Kit Label, IQ System Controller 200G	1
Label, Enpower, CT Field	Label		6
Label, Enpower, PCS Field	Label		2
Cable Assy Header Enpower 200G R2	Cable Assembly	Cable Assy Header IQ System Controller 200G R2	4
NEC Labels for Rapid Shutdown	Label	Labels required as per NEC for Rapid Shutdown Switch	2
Wiring for Rapid Shutdown Switch	Wire	20 ft. of color coded wires to complete Rapid Shutdown Switch wiring	4

Tools / Additional items required

S. NO	ITEM NAME	QUANTITY	SOURCE
1	CT-200-Split	2	IQ Combiner/Enphase Store
2	EP200G-HNDL-R1 (lifting handle)	1	Enphase Store
3	Breakers different ratings	4	Enphase Store/Retail outlets
4	Conduits (with fittings and Fitting tools)	As required	Provided by Installer
5	Drill	1	Provided by Installer
6	5/32 inch pilot bit	1	Provided by Installer
7	Screw driver	1	Provided by Installer
8	Wrench	1	Provided by Installer
9	Adjustable Wrench	1	Provided by Installer
10	Torque wrench	1	Provided by Installer
11	Level	1	Provided by Installer
12	5/32 inch Allen key	1	Provided by Installer
13	Conductor stripper	1	Provided by Installer
14	Electrician's hole saw (2 inch) or punch set	1	Provided by Installer
15	Stud finder (if required)	1	Provided by Installer
16	Conduit ground hub rings	1	Provided by Installer
17	#10,1/4" or 5/16" lag bolts or screw 3" long (depending on attaching wall) - for each wall mount bracket	3	Provided by Installer

Section A

Mounting the product

Plan a location for the IQ System Controller 2



- It is recommended to install the product indoors, if the product is installed outdoors it is recommended to be installed where there is no direct exposure to sunlight.
- Install this product on the place where PV cables, smart meter cables, grid cables and battery cables are easily accessible.

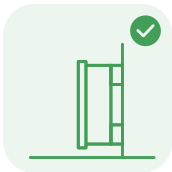

- This product is designed to be installed on the wall vertical only. Do not install this product on the ground.
- The mounting surface must be able to support the weight of this product (87 lbs).



- Appropriate operating temperature is from -40 to 50 degrees celsius.
- Do not install this product in the place exposed to the direct sunlight.
- Install the product in a clean, cool room.



- This product must not be installed or used at altitudes above 8200 ft (2500 m).



- Do not install this product in places where flooding occurs.

Section A - Mounting the product

Step 1: Minimum clearance

This product must be installed with clearance at the left, right, top, bottom and front of the product as shown in the figure.

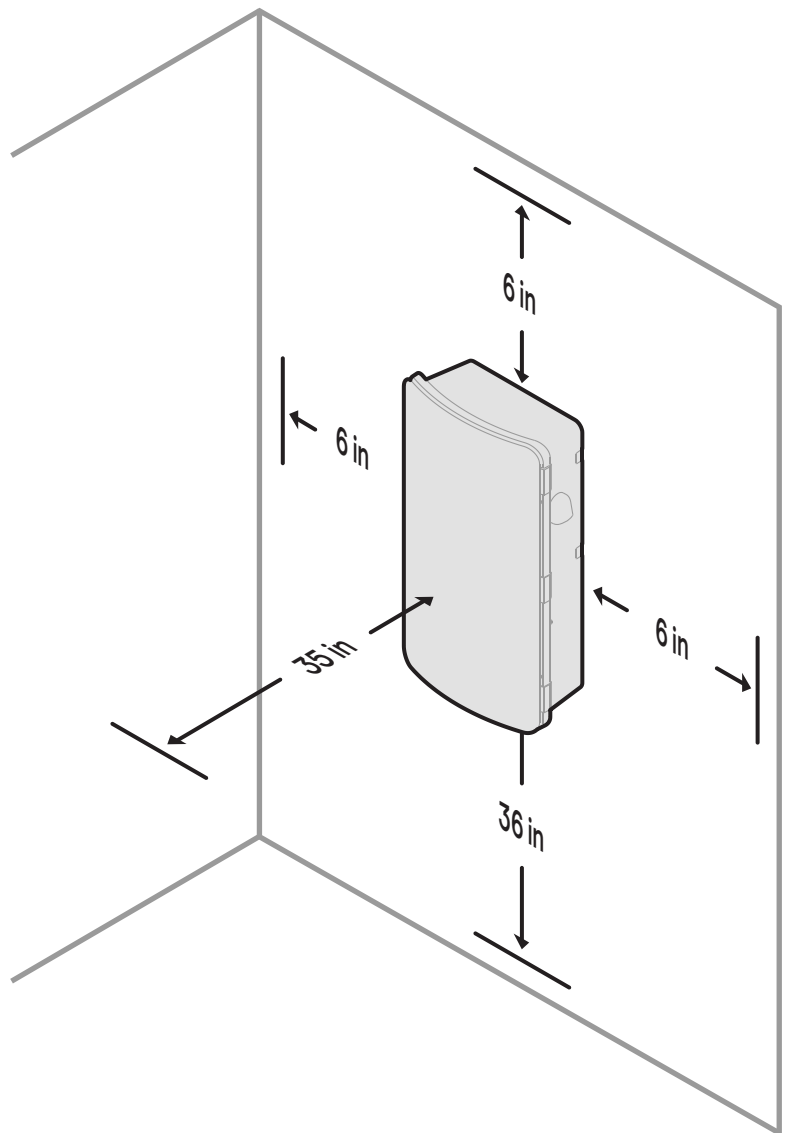
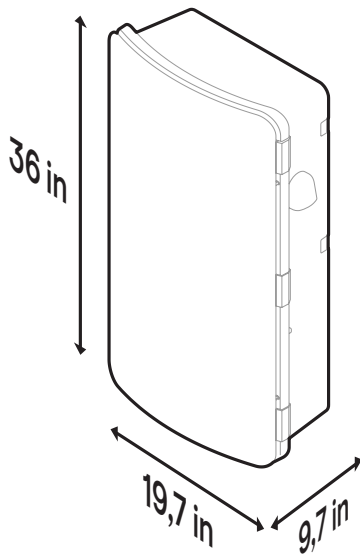

Section A - Mounting the product

Step 2: Installing the mounting bracket

Installing the mounting bracket and mount the IQ System Controller 2 as per instructions below. Please note the following before installing

1. The IQ System Controller 2 smart switch weighs 39.4 kg (87 lbs) and will require two persons to lift the unit.
2. Risk of injury and equipment damage. Avoid dropping the IQ System Controller 2. Doing so may create a hazard, cause serious injury, and/or damage the equipment.

3. Risk of injury and equipment damage. Do not release the IQ System Controller 2 until you ensure that the IQ System Controller 2 is fully seated in the wall-mount bracket shelf.
4. Three #10, 1/4", or 5/16" lag bolts or screws, 7.6cm (three inches) long (depending on attachment wall), for each wall-mount bracket.
5. Check with a structural engineer and local standards for local requirements. Washers to be used between fastener heads and wall-mount bracket.

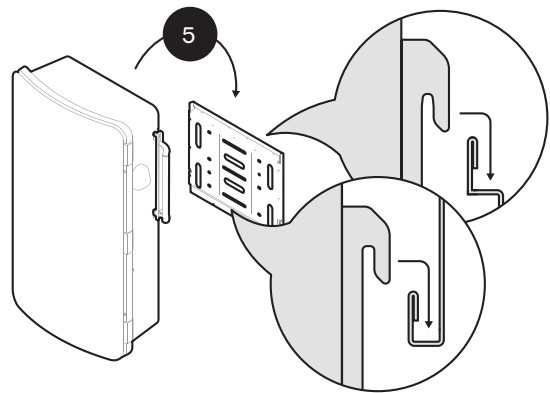
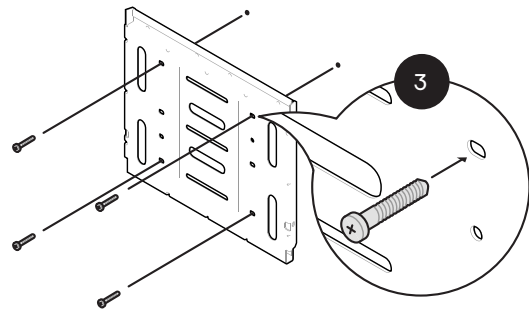
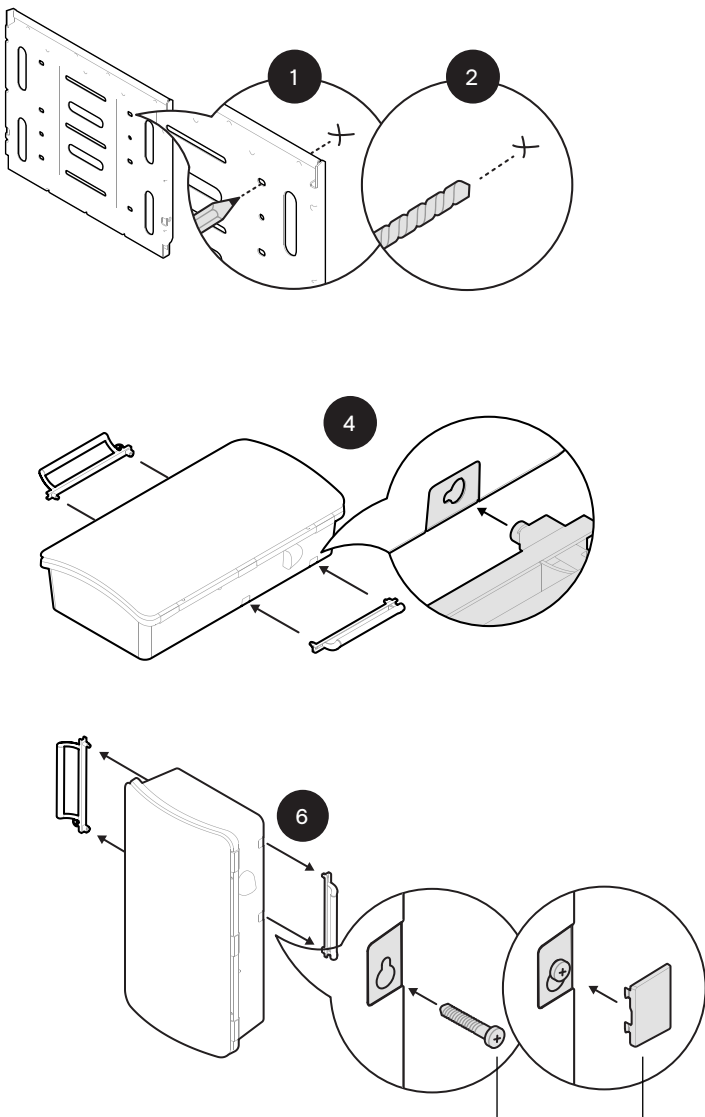

Provided in Accessory Kit

Section A - Mounting the product

Step 3: Open the dead front

Before removing the deadfront, ensure the IQ System Controller 2 is completely de-energized.

Please note the following

1. Risk of equipment damage. Do not remove the pre-installed solar shield attached to the enclosure door.
2. Risk of electric shock. To maintain the warranty, do not modify the deadfront other than to remove or replace filler plates, as needed.

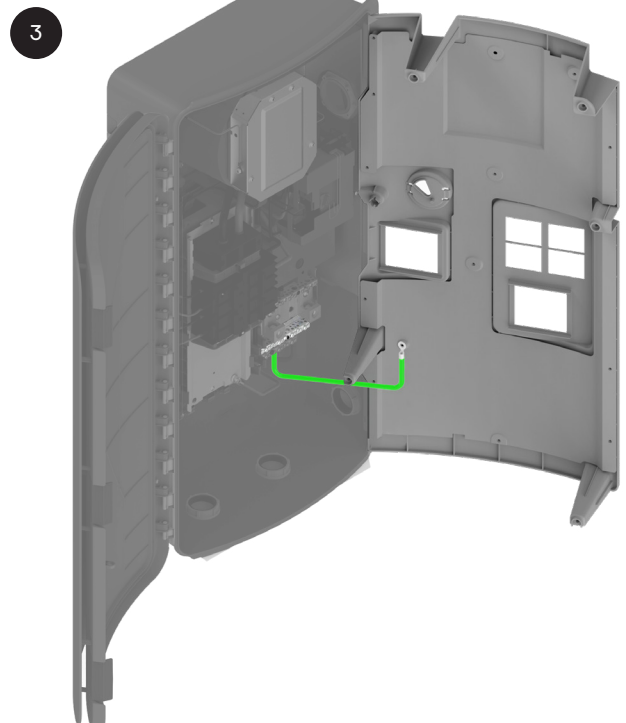
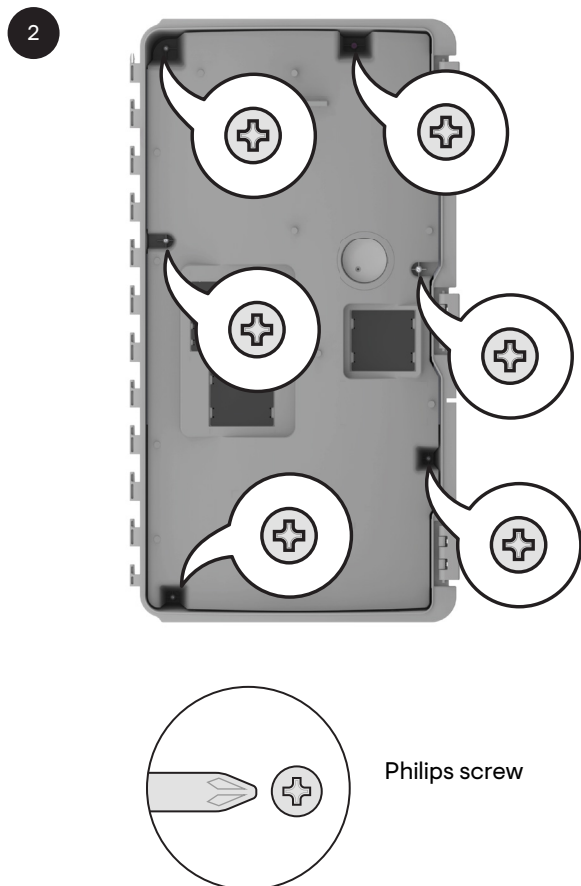
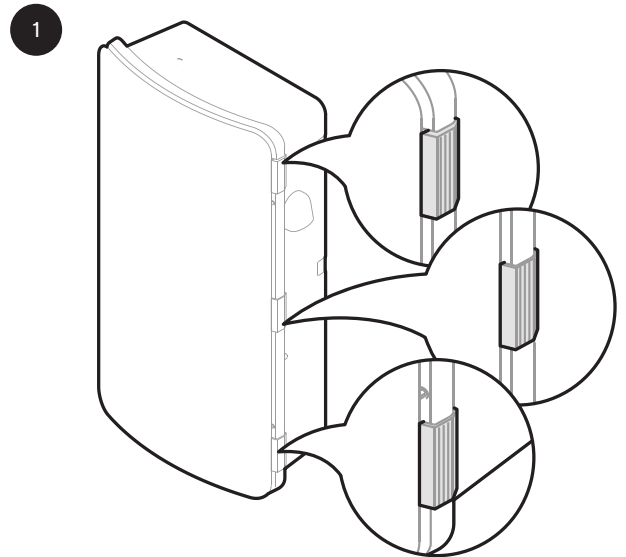

The ground connection to deadfront needs to be carefully disconnected before the deadfront can be dismantled from the IQ System Controller 2

Section B

Mounting the breakers

Internal schematic of IQ System Controller 2

Once the deadfront is removed the IQ System Controller 2 looks as below. It comes with an inbuilt neutral forming transformer, microgrid interconnection device, automatic transfer switch and a panel board to mount plug in type breakers.

A detailed schematic can be found in the image below

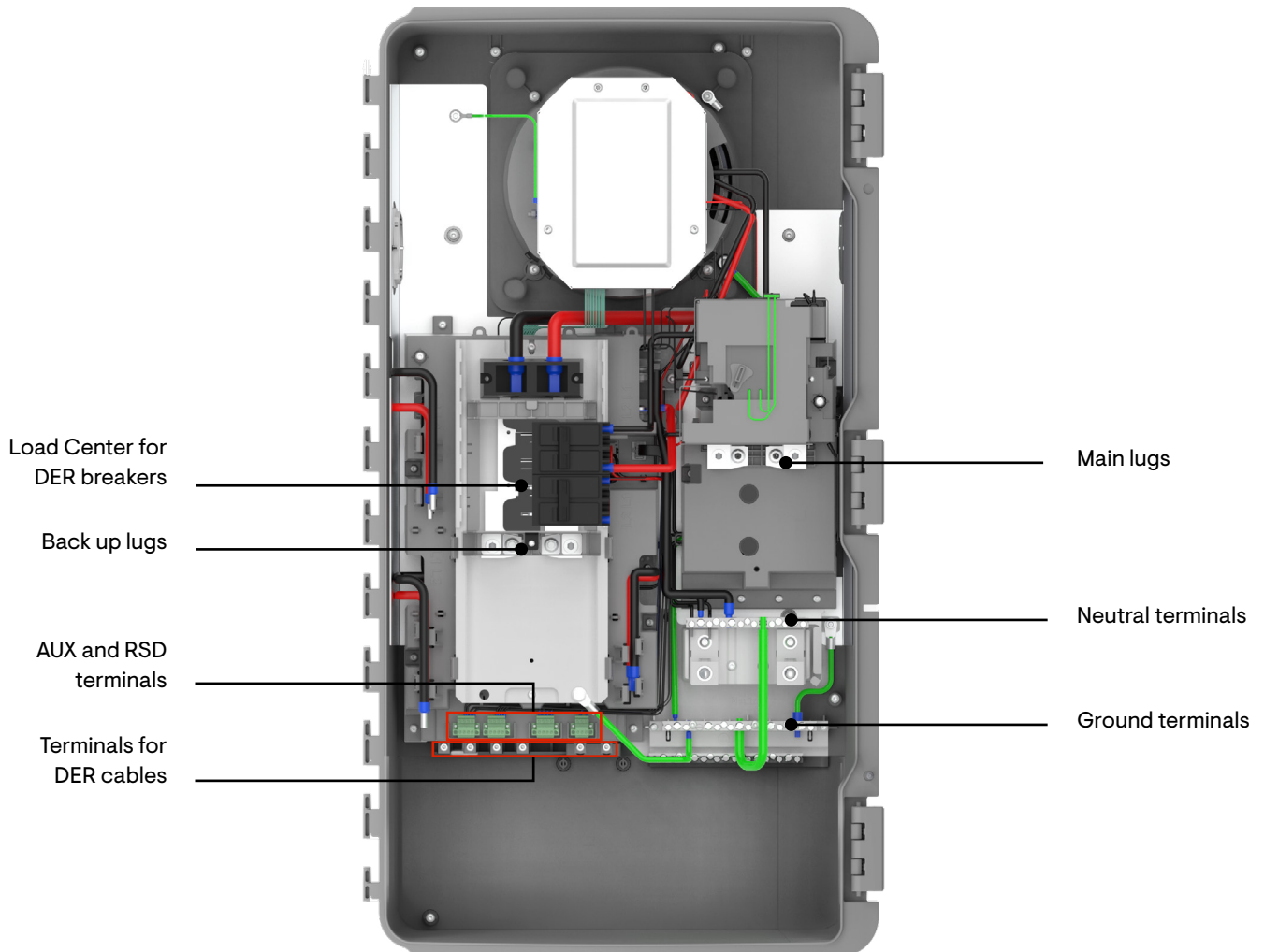

Section B - Mounting the breakers

Wiring for service entrance

If the IQ System Controller 2 is used as a service entrance equipment

- Do not remove the green colored ground neutral jumper
- Paste Labels provided in Accessory Kit

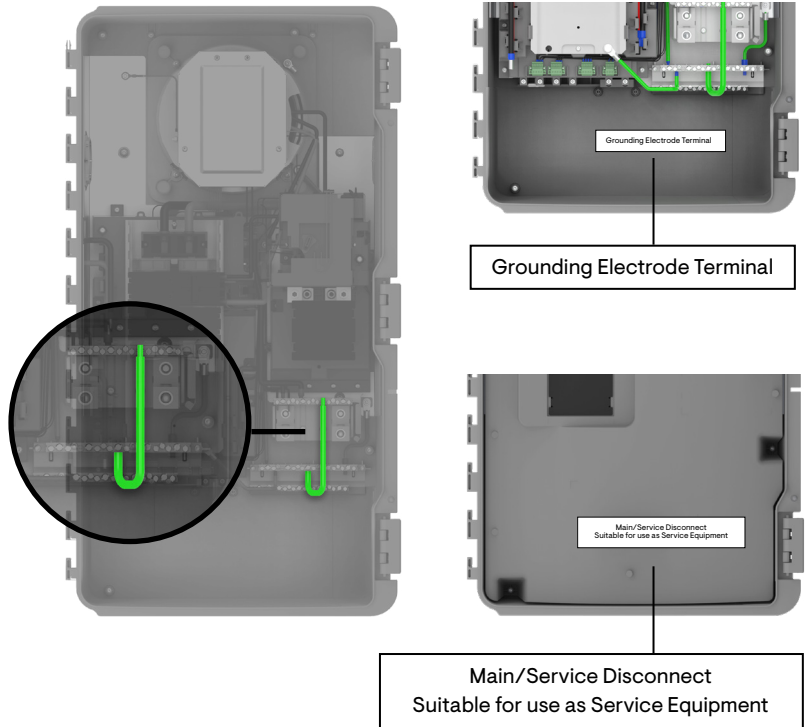

If the IQ System Controller 2 is NOT used as a service entrance equipment

- Remove the Ground Neutral Jumper wire

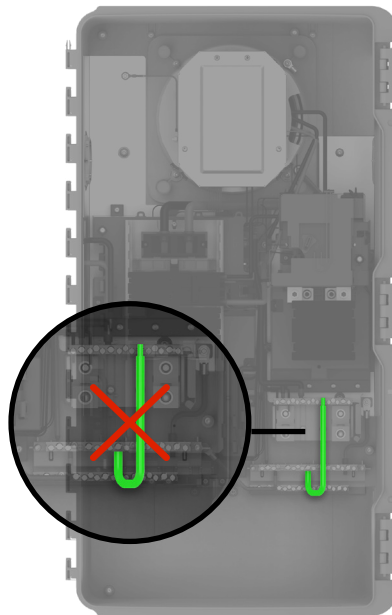

Section B - Mounting the breakers

Install main and back-up breakers

If breakers are being installed for mains and back up connections the lugs should be removed and the breakers should be installed.

Before wiring the breaker ensure the IQ System Controller 2 is completely De-energized.

Only Eaton CSR range breakers with ratings between 100-200A can be used.

ENPHASE BREAKER SKU	EATON BREAKER PART
BRK-100A-2P-240V	CSR2100N
BRK-125A-2P-240V	CSR2125N
BRK-150A-2P-240V	CSR2150N
BRK-175A-2P-240V	CSR2175N
BRK-200A-2P-240V	CSR2200N

Back-up Connection

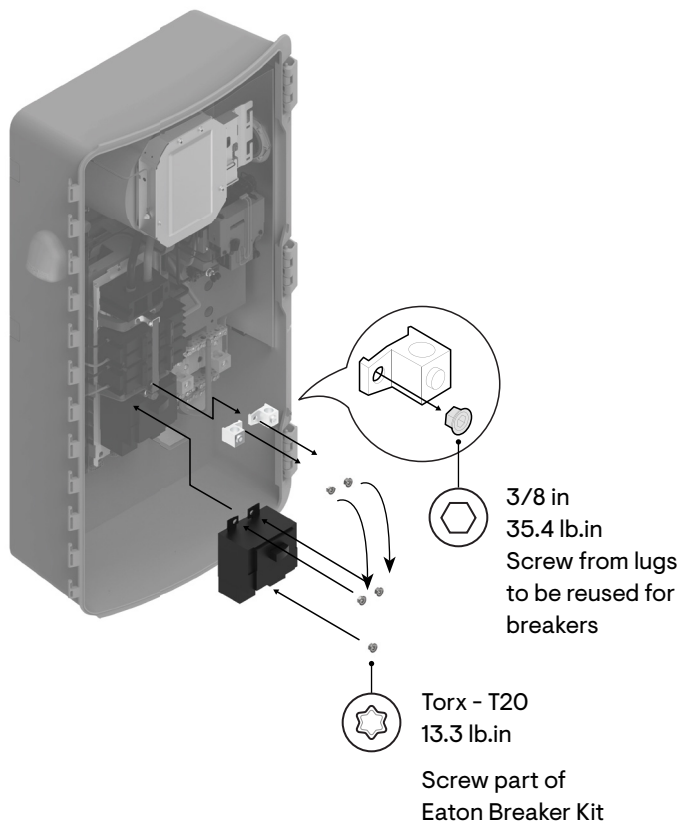

Main Connection

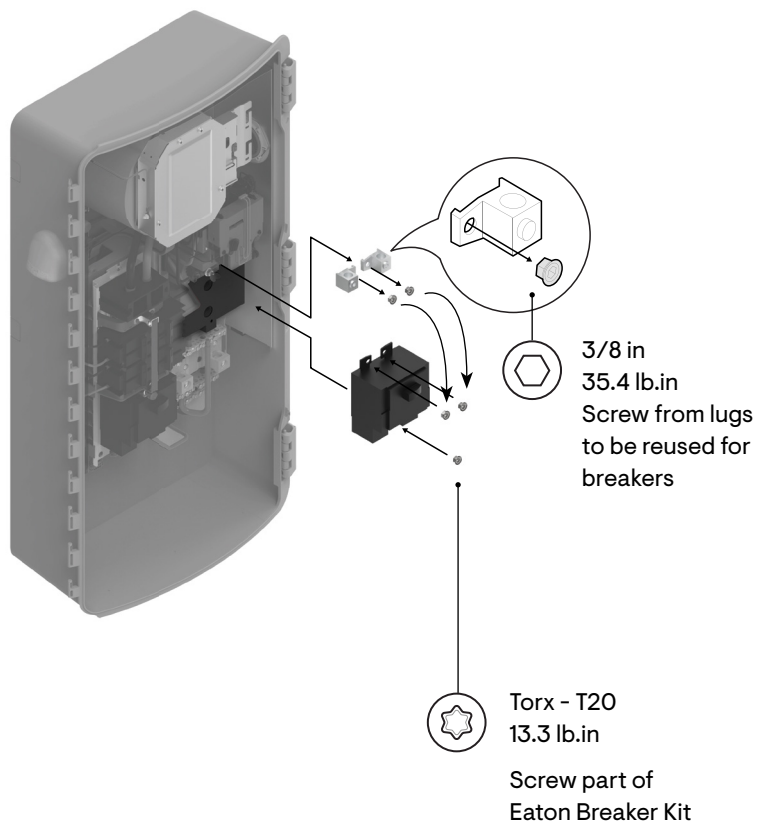

Section B - Mounting the breakers

Installing DER breakers for IQ8 Systems without Generator

The IQ System Controller 2 comes pre-installed with a 40A breaker for the neutral forming transformer (NFT) . When a generator is not being installed the NFT breaker need not be disturbed.

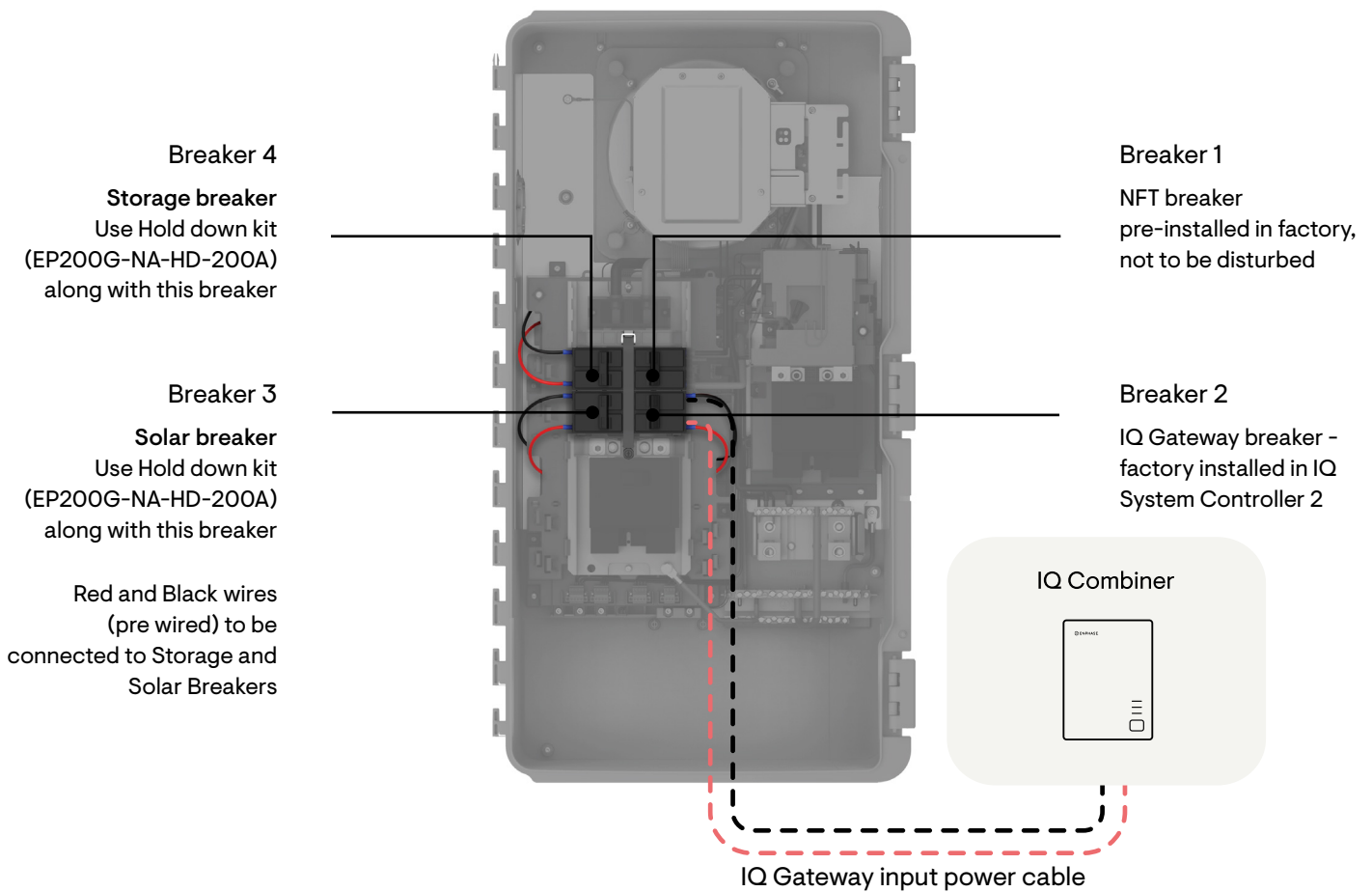

ENPHASE BREAKER PART	EATON BREAKER PART	TORQUE
BRK-10A-2P-240V-B	BR210B	27 lb.in
BRK-15A-2P-240V-B	BR215B	
BRK-20A-2P-240V-B	BR220B	
BRK-40A-2P-240V-B	BR240B	
BRK-60A-2P-240V	BR260	
BRK-80A-2P-240V	BR280	

Section B - Mounting the breakers

Installing DER breakers for IQ8 Systems with Generator

IQ System Controller 2 allows for generator integration with the Enphase Energy Systems. The breaker on the bottom right slot can be sized and used to integrate the generator. For wiring schematic on Generator control and wiring the power lines from generator the subsequent section of installation guide.

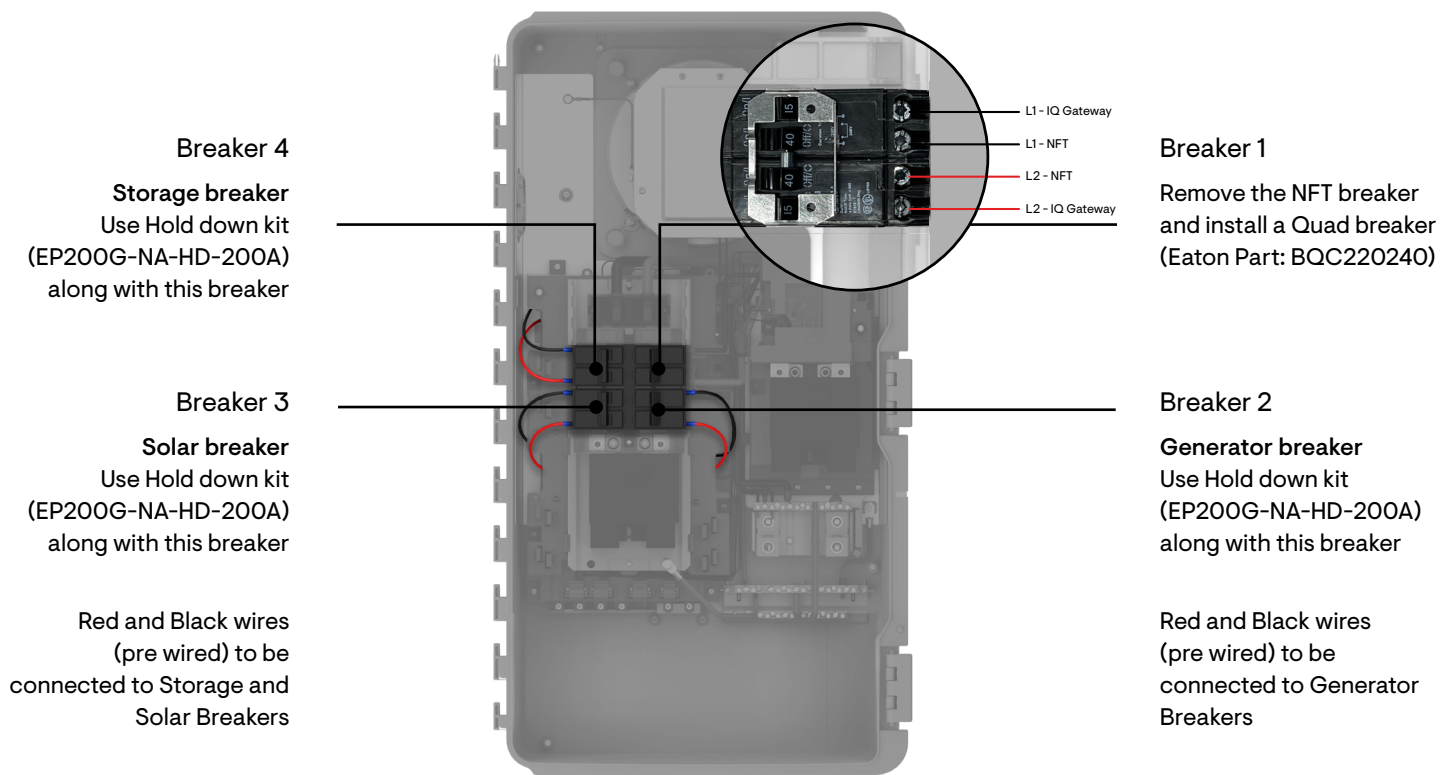

ENPHASE BREAKER PART	EATON BREAKER PART	TORQUE ON WIRE
BRK-10A-2P-240V-B	BR210B	27 Lb.in
BRK-15A-2P-240V-B	BR215B	
BRK-20A-2P-240V-B	BR220B	
BRK-40A-2P-240V-B	BR240B	
BRK-60A-2P-240V	BR260	
BRK-80A-2P-240V	BR280	

Section B - Mounting the breakers

Installing DER breakers for non IQ8 Systems

The IQ System Controller 2 comes pre-installed with a 40A breaker for the neutral forming transformer (NFT) . When a generator is not being installed the NFT breaker need not be disturbed.

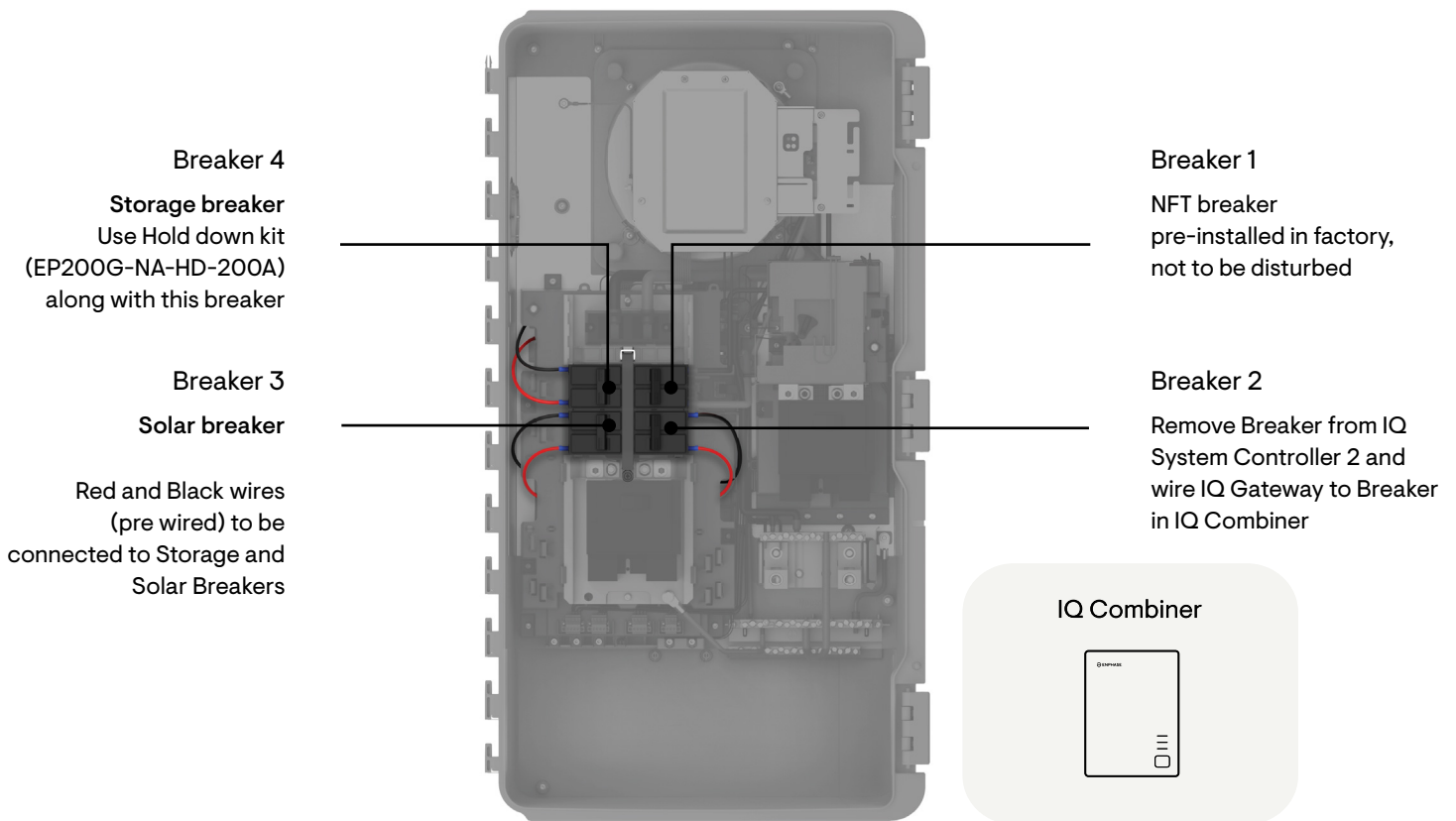

ENPHASE BREAKER PART	EATON BREAKER PART	TORQUE ON WIRE
BRK-10A-2P-240V-B	BR210B	27 lb.in
BRK-15A-2P-240V-B	BR215B	
BRK-20A-2P-240V-B	BR220B	
BRK-40A-2P-240V-B	BR240B	
BRK-60A-2P-240V	BR260	
BRK-80A-2P-240V	BR280	

Section C

Wiring

Drill conduits

Drill conduit entry holes as needed, and install conduit grounding lugs for each opening. Be sure to reseal unused conduit entry holes with sealing plugs.

NOTE: Main supply conductors may enter the IQ System Controller 2 from the bottom or from the bottom-left side. Backup load conductors may enter the IQ System Controller 2 from the bottom or bottom-right side. IQ Battery, IQ Combiner and generator conductors may enter from the bottom, bottom-left or bottom-right sides.

Size the conductors (Line, Neutral and Ground) depending on the breaker or fuse, proper ampacity, and voltage rise requirements according to local codes.

Refer to the conductor rating table on the door of the IQ System Controller 2.

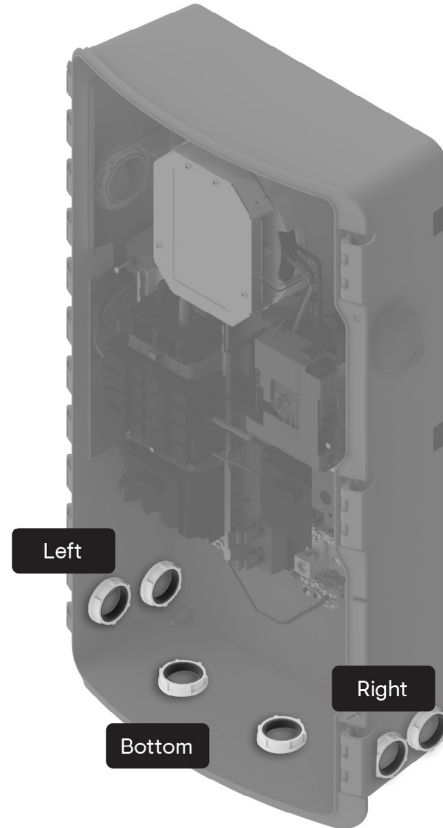

CONDUIT LOCATION	MAIN	BACK UP	DER
Bottom	✓	✓	✓
Left wall	✓	✗	✓
Right wall	✗	✓	✓

Section C - Wiring

DER wiring

The DERs (IQ Battery, AC Combiner/Solar and generator) wires need to be connected to the lugs at the bottom as indicated in the images below.

Before connecting the wires refer the wiring table recommendation and torque recommendation and also refer to local codes for any specific local requirements.

Battery wiring

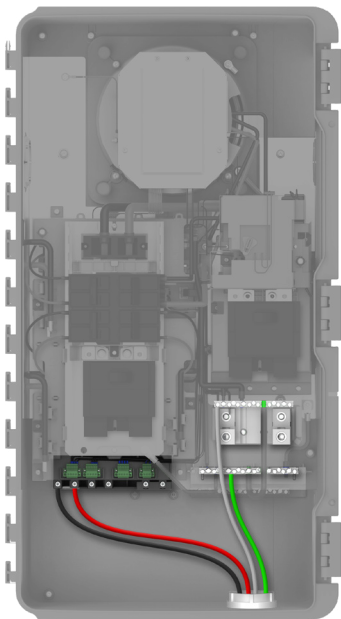

PV wiring

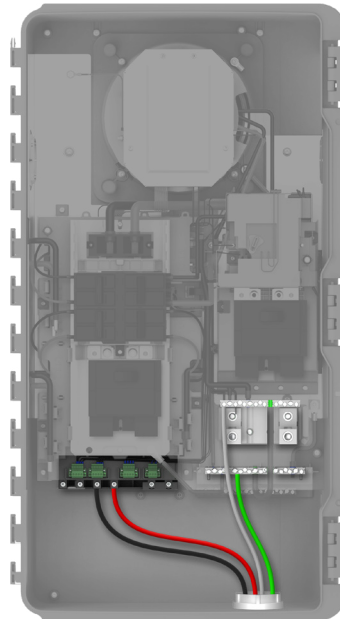

Generator wiring

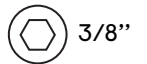
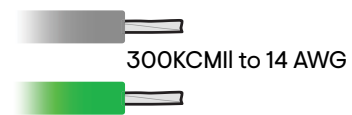
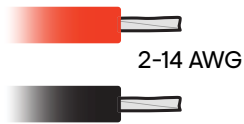
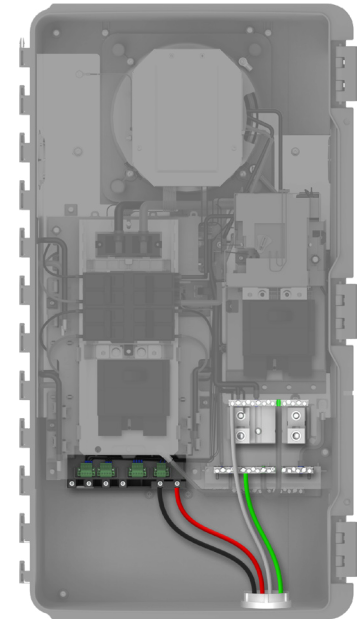

AWG	TORQUE (LB.IN)
14 -10	25
8	30
4 - 6	35
2 - 3	40

AWG	TORQUE (LB.IN)
1/0 - 3	50
4 - 6	45
8	40
10 - 14	35
6 - 8	25
10 - 14	15

Section C - Wiring

Aux wiring: Rapid shutdown switch

Aux Wiring 1: RSD wiring (Compliance requirement)

Rapid shutdown is a compliance requirement as per the NEC and the UL1741. This is needed in order to ensure that there will be a single point shutdown for all solar panels. Enphase Energy System Shutdown meets the future requirements by disconnecting the battery too.

For non-IQ8 systems please refer to design guide

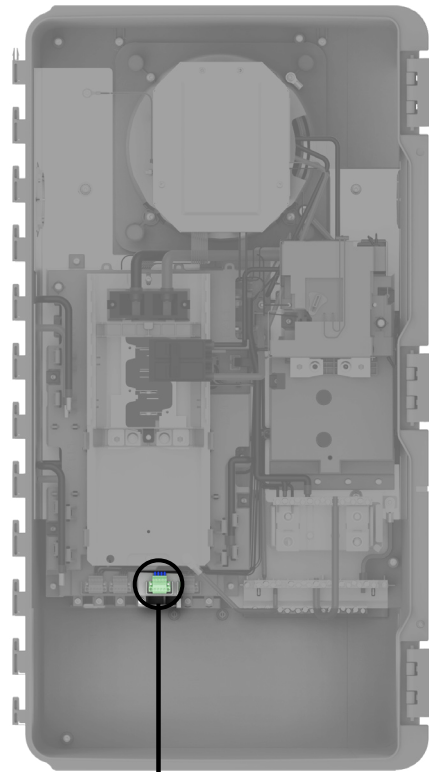

Wiring for systems with IQ8 Microinverters

Wiring for systems with non-IQ8 Microinverters

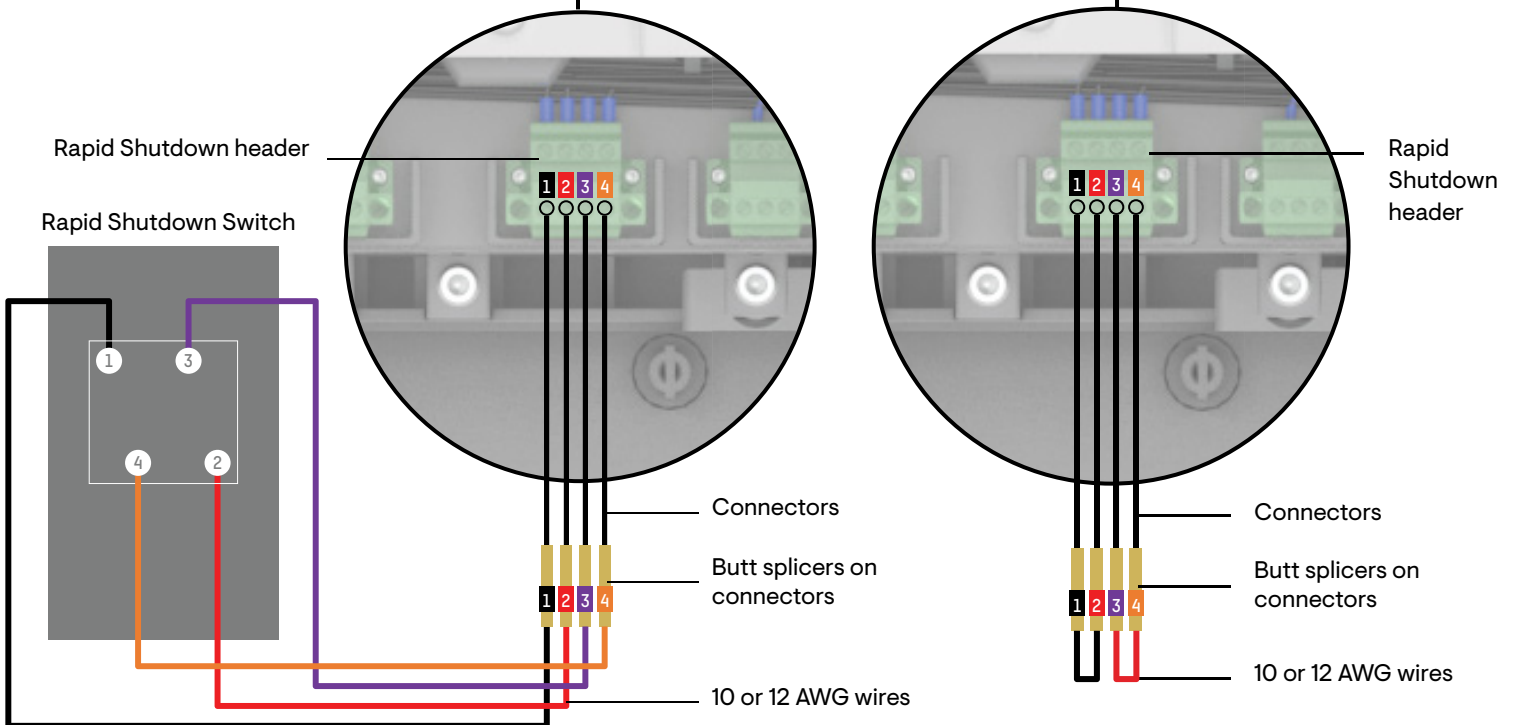

NOTE: Supports AWG 28 to AWG 16 wire sizes.

Section C - Wiring

Aux wiring: IQ Load Controller

IQ Load Controller is a feature of the IQ System Controller 2 which can be used to control upto 4x 240V loads or 8x 120V loads. At least one IQ Load Controller is needed for Sunlight Back-up systems.

For a detailed wiring instruction refer to the IQ Load Controller QIG

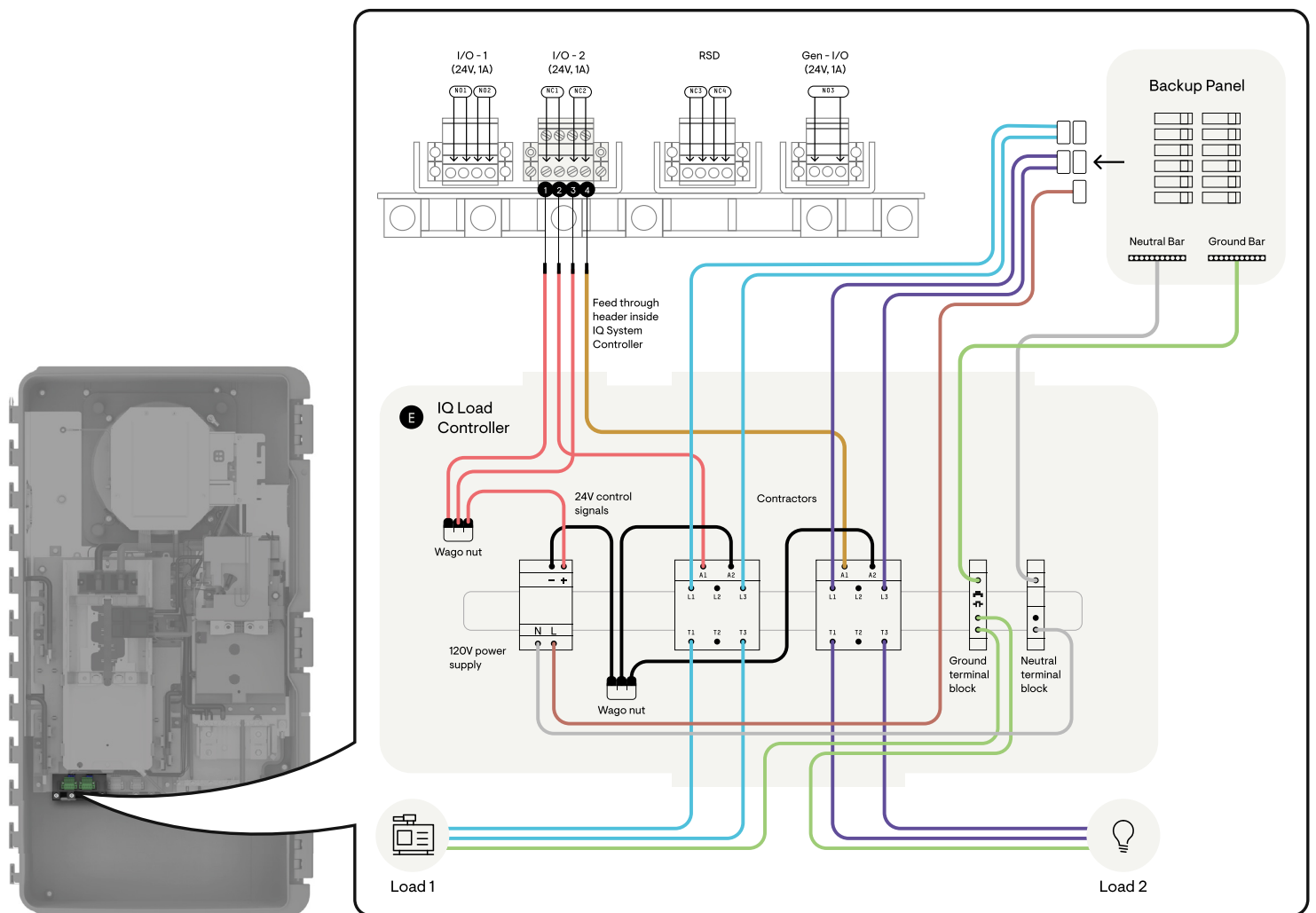

NOTE: Supports AWG 28 to AWG 16 wire sizes.

Section C - Wiring

Aux wiring: Generator control

An auto-start generator can be integrated with the Enphase Storage system without the need for any external ATS.

1. Install a pair of generator CTs (CT-200-SPLIT) for L1 and L2 at the IQ System Controller 2 Generator input terminal for power monitoring when the generator is running.
2. Use Enphase Installer Toolkit mobile application to commission and program IQ System Controller 2 to control the generator.

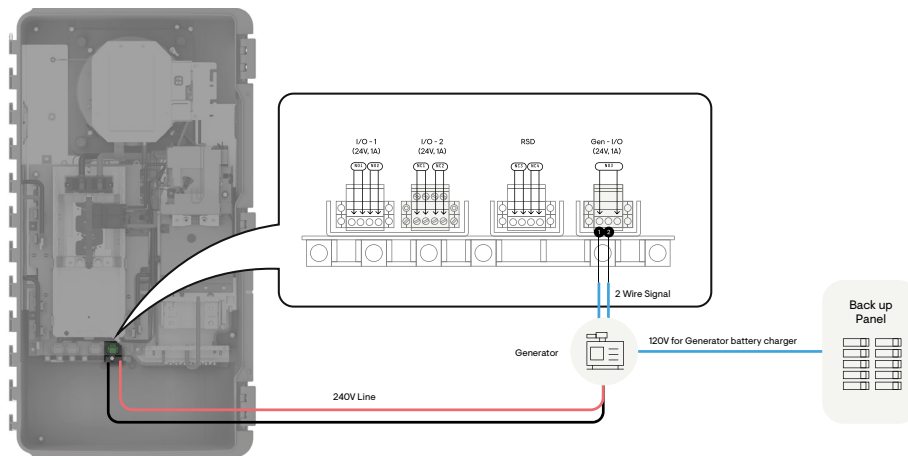

For 2-wire autostart generators, wire the Generator I/O port in IQ System Controller 2 to the 2-wire remote start terminals of the generator.

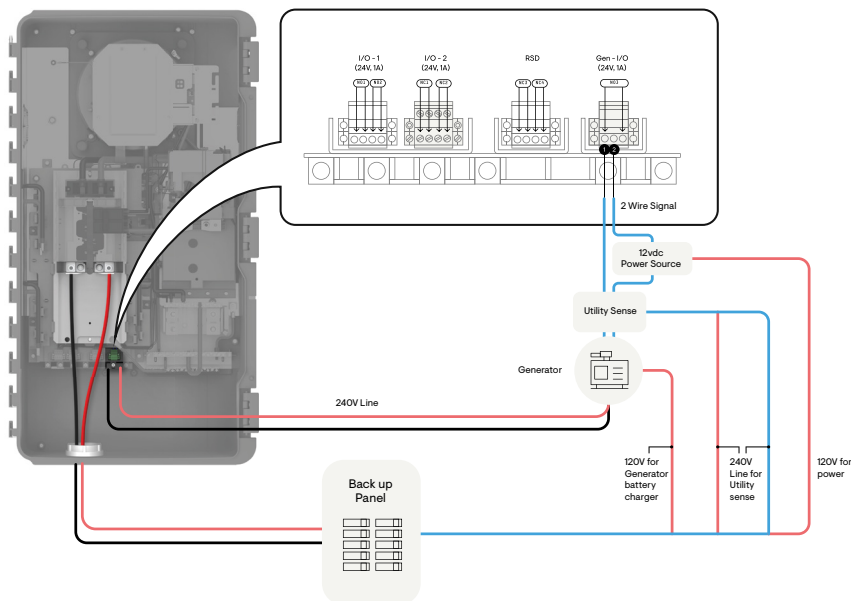

Wire the primary of a 120V/12V power supply to the backup loads panel. Connect the secondary to the Generator auxiliary contact relay on the IQ System Controller 2. Wire the other end of the relay to the coil of the Normally Close contactor. Connect the contactor to 240V from the backup loads panel for utility sensing. Wire the other end of the contactor to the Generator through a fuse.

NOTE: Supports AWG 28 to AWG 16 wire sizes.

Section C - Wiring

Mains / Supply side wiring

The mains wiring is to be the final step in the installation process. The wiring is similar for both full home and partial home back up.

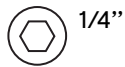
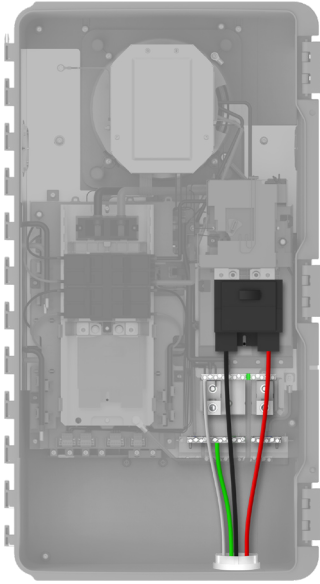

AWG	TORQUE (LB.IN)
300kcmil-2	250

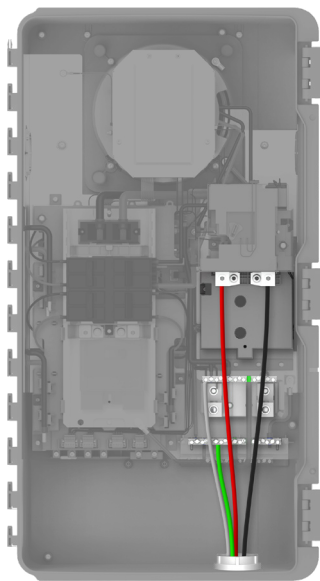
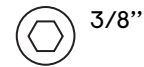
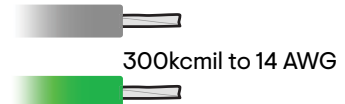

AWG	TORQUE (LB.IN)
300kcmil-2	275

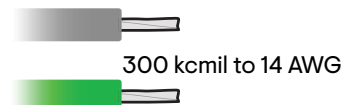

	AWG	TORQUE (LB.IN)
Neutral and Ground bar – large holes	1/0 - 3	50
	4 - 6	45
	8	40
	10 - 14	35
Neutral and Ground bar – small holes	6 - 8	25
	10 - 14	15
Larger neutral bar	300kcmil - 6	275

Section C - Wiring

Back-up loads wiring

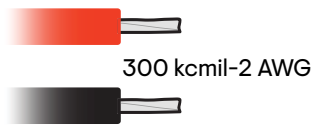
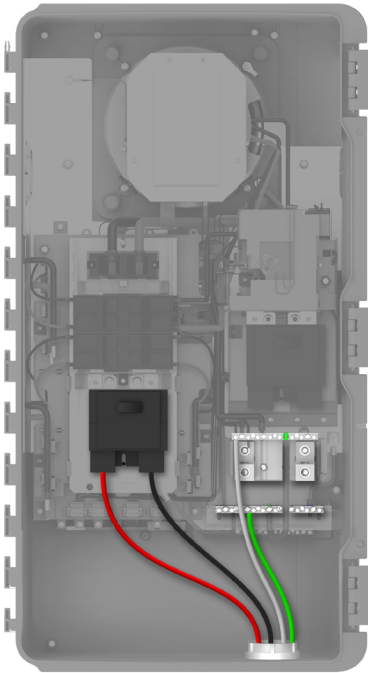

1/4"

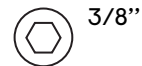

3/8"

AWG	TORQUE (LB.IN)
300kcmil-2	250

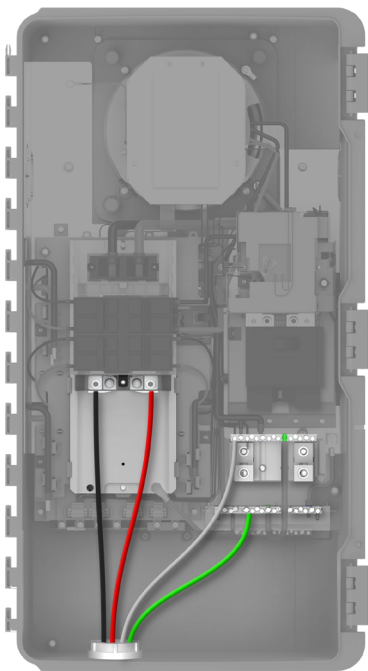

1/4"

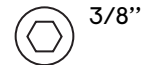
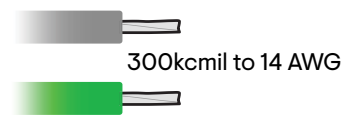

3/8"

AWG	TORQUE (LB.IN)
300kcmil-2	275

	AWG	TORQUE (LB.IN)
Neutral and Ground bar – large holes	1/0 - 3	50
	4 - 6	45
	8	40
	10 - 14	35
Neutral and Ground bar – small holes	6 - 8	25
	10 - 14	15
Larger neutral bar	300kcmil - 6	275

Section C - Wiring

CT wiring

There are multiple scenarios for CT wirings for a complete description please refer to IQ Gateway QIG.

For PCS , whole home and complete home back up the consumption CTs are to be placed as described in image

For PCS set up please refer to the Enphase installer APP.

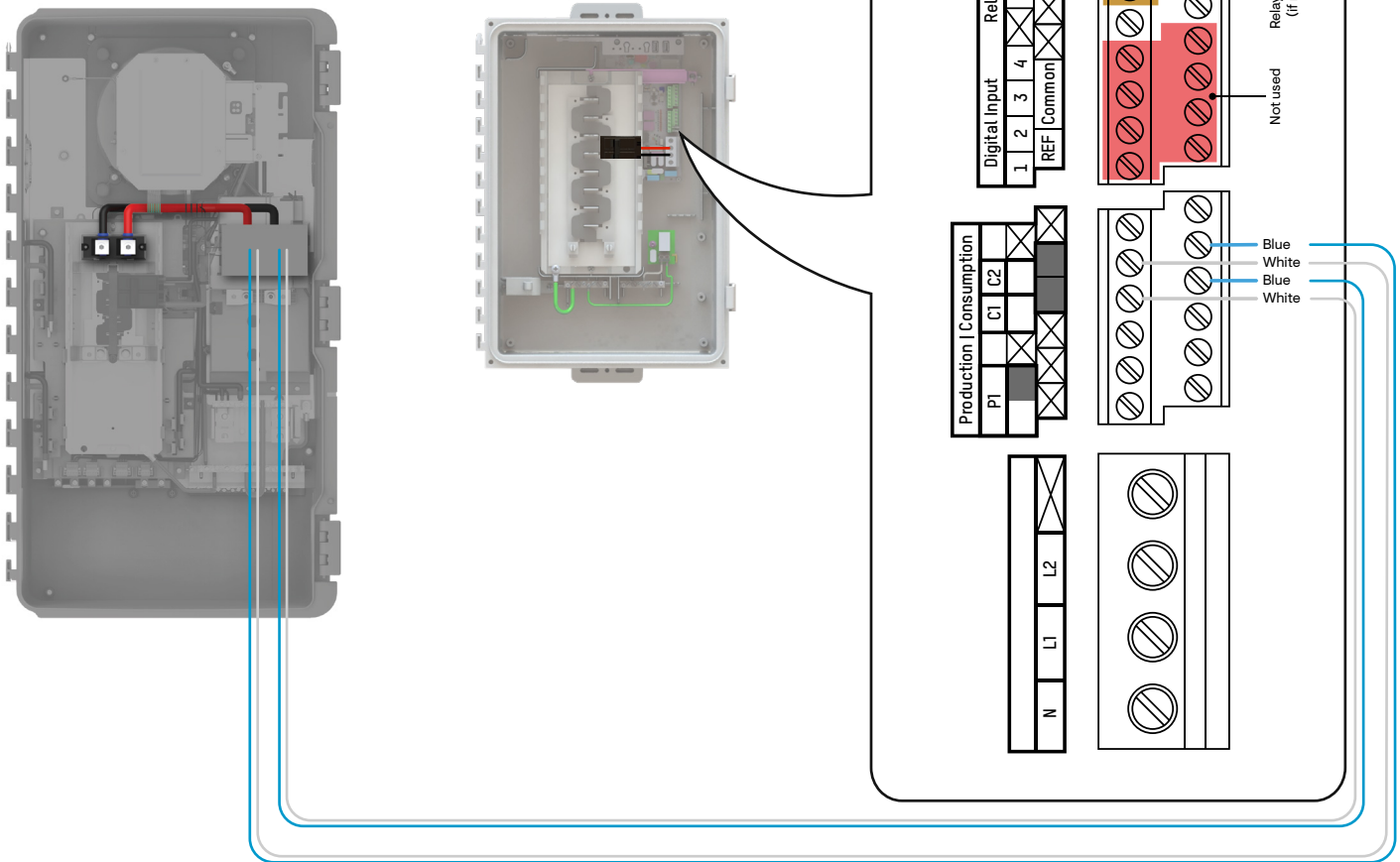

After placing the Consumption CT and wiring to the IQ Gateway the following label has to be pasted on the CT.

This sensor is part of a Power Control System. Do not remove or disable. Replace with same type and rating.

If PCS is being used place the following label on the deadfront with the PCS setting filled in the blank space.

THE MAXIMUM CURRENT BACKFED BY THIS SYSTEM TO THE MAIN PANEL MAY BE CONTROLLED ELECTRONICALLY. REFER TO MANUFACTURER'S INSTRUCTIONS FOR MORE INFORMATION
 PCS CONTROLLED CURRENT SETTINGS: AMPS

When installing a generator the Generator CT should be paralleled to the Consumption CT wiring using a wago nut.

Close and energize IQ System Controller 2

 **WARNING:** Before energizing, make sure that All IQ System Controller 2 connections are properly installed and conductors terminated.

- A. Reconnect the deadfront ground cable to the grounding bar, torque as shown in the start of the guide, and replace the deadfront using the 5 reserved screws. Tighten the cover screws using a Phillips screw driver.

 **WARNING!** Risk of equipment damage. Ensure that no conductors are pinched before replacing the cover.

 **WARNING!** Conductors are factory provided for the generator, AC Combiner and IQ Battery. If no generator is used with the system, these conductors will not be terminated. If the Combiner does not connect to the IQ System Controller 2, these will also not be terminated. When these wires are not terminated, they should remain stowed in the clips on the plastic frame supporting the panel board interior and their end caps should not be removed.

 **DANGER:** Risk of electric shock. There are many potential sources of voltage. Check any Enphase IQ Battery, PV, or other generation source for voltage.

- B. You must ensure that all electrical circuits external to IQ System Controller 2 are completed and safe before energizing IQ System Controller 2.
- C. If you work on an IQ6/7/M-series retrofit system, and you plan to energize IQ System Controller 2 and connect the PV without commissioning the system in the same day, follow the sequence below:
 - a. Leave the AC combiner breaker in the load panel where it was originally placed, instead of connecting the AC combiner L1 and L2 circuits to the terminal lugs in IQ System Controller 2. This way your PV systems can still be functional before commissioning.
 - b. OPEN the NFT and IQ Battery breakers
 - c. CLOSE the breakers in the following order:
 - Main breaker
 - Load breaker

 **WARNING!** At commissioning, you must reconnect the AC combiner L1 and L2 circuits back to the terminal lugs in IQ System Controller 2 as shown in step 5(F) in this document.

 **NOTE:** If not commissioning the system you must ensure that the DC switches on all IQ Battery batteries are turned off to avoid the depletion of charge on the IQ Battery batteries.

- D. If you plan to commission the system, follow the instructions in the Enphase Installer Toolkit app for energizing IQ System Controller 2.
- E. Energize the circuit feeding the IQ System Controller 2. If installed, turn the breaker feeding the IQ System Controller 2 to the on position.
- F. Close and secure the door of the IQ System Controller 2.

Configure and activate

1. Use the Enphase Installer App to commission the IQ System Controller 2
2. Once connected to the IQ Gateway, refer to the Enphase Installer App help topics for more information.

Operation

If you do not see the IQ System Controller 2 information in Enphase Installer App, check that the IQ Gateway and the Internet connection are working.

Safety

IMPORTANT SAFETY INSTRUCTIONS. SAVE THESE INSTRUCTIONS. This guide contains important instructions that you must follow during installation and maintenance of the Enphase IQ System Controller 2. Failing to follow any of these instructions may void the warranty (enphase.com/warranty).

In Case of Fire or Other Emergency

In all cases:

- If safe to do so, switch off the AC breaker for the IQ System Controller 2 circuit, and if an isolator switch is present, switch off the AC isolator for the IQ System Controller 2 circuit.
- Contact the fire department or other required emergency response team.
- Evacuate the area.

In case of fire:

- When safe, use a fire extinguisher. Suitable types are A, B, and C dry chemical fire extinguishers. Additional extinguishing media include carbon dioxide, or alcohol-resistant foams.



In case of flooding:

- Stay out of water if any part of the IQ System Controller 2 or wiring is submerged.
- If possible, protect the system by finding and stopping the source of the water, and pumping it away.
- If water has contacted the UNIT, call your installer to arrange an inspection. If you are sure that water has never contacted the battery, let the area dry completely before use.







In case of unusual noise, smell or smoke:

















- Ensure nothing is in contact with the IQ System Controller 2 or in the venting area on top of the IQ System Controller 2.
- Ventilate the room.
- Contact Enphase Customer Support at enphase.com/en-us/support/contact.

Safety and Advisory Symbols

-  **DANGER:** This indicates a hazardous situation, which if not avoided, will result in death or serious injury.
-  **WARNING:** This indicates a situation where failure to follow instructions may be a safety hazard or cause equipment malfunction. Use extreme caution and follow instructions carefully.
-  **NOTE:** This indicates information particularly important for optimal system operation. Follow instructions carefully.

Safety Instructions

-  **DANGER:** Risk of electric shock. Risk of fire. Only qualified electricians should install, troubleshoot, or replace the IQ System Controller 2.
-  **DANGER:** Risk of electric shock. Risk of fire. Do not attempt to repair the IQ System Controller 2. Tampering with or opening the IQ System Controller 2 will void the warranty. If the IQ System Controller 2 fails, contact Enphase Customer Support for assistance at enphase.com/en-us/support/contact.
-  **DANGER:** Risk of electric shock. Do not use Enphase equipment in a manner not specified by the manufacturer. Doing so may cause death or injury to persons, or damage to equipment.
-  **DANGER:** Risk of electric shock. Do not install the IQ System Controller 2 without first removing AC power from the photovoltaic system and ensuring that the DC switch on the IQ Batteries are off. Disconnect the power coming from the photovoltaics and ensure that the DC switch on the IQ Battery batteries are off before servicing or installing.
-  **DANGER:** Risk of electric shock. Risk of fire. Do not work alone. Someone should be in the range of your voice or close enough to come to your aid when you work with or near electrical equipment.
-  **DANGER:** Risk of fire. Do not allow or place flammable, sparking, or explosive items near the IQ System Controller 2.
-  **DANGER:** Risk of electric shock. In areas where flooding is possible, install the IQ System Controller 2 at a height that prevents water ingress.

-  **WARNING:** Risk of equipment damage. IQ System Controller 2 is shipped and stored on its back. The upright position is only needed when installed.
-  **WARNING:** You must install the IQ System Controller 2 only on a suitable wall using an Enphase wall-mount bracket.
-  **WARNING:** Before installing or using the IQ System Controller 2, read all instructions and cautionary markings in this guide and on the equipment.
-  **WARNING:** Do not install or use the IQ System Controller 2 if it has been damaged in any way.
-  **WARNING:** Do not sit on, step on, place objects on, or insert objects into the IQ System Controller 2.
-  **WARNING:** Do not place beverages or liquid containers on top of the IQ System Controller 2. Do not expose the IQ System Controller 2 to flooding.
-  **NOTE:** Perform installation and wiring, including protection against lightning and resulting voltage surge, in accordance with all applicable local electrical codes and standards.
-  **NOTE:** Because IQ Battery is grid forming, you must install signage in accordance with NEC articles 705, 706, and 710.
-  **NOTE:** Using unapproved attachments or accessories could result in damage or injury.
-  **NOTE:** Install properly rated over current protection as part of the system installation.
-  **NOTE:** To ensure optimal reliability and to meet warranty requirements, the IQ System Controller 2 must be installed and/or stored according to the instructions in this guide.
-  **NOTE:** The IQ System Controller 2 is compatible only with the IQ Combiner 4/4C fitted with USB hub, USB radios, and production and Consumption/PCS CTs. The IQ Combiner with the IQ Gateway inside is required for operation of the IQ System Controller 2. Earlier versions of the Enphase IQ Gateway communications gateway are incompatible.
-  **NOTE:** The Enphase IQ System Controller 2 is intended to operate with an Internet connection through the IQ Gateway. Failure to maintain an Internet connection may have an impact on the warranty. See Limited Warranty for full terms and services (enphase.com/warranty).
-  **NOTE:** When replacing an Enphase IQ System Controller 2, you must replace it with an IQ System Controller 2 of the same type, with the same AC current rating.
-  **NOTE:** Properly mount the IQ System Controller 2. Ensure that the mounting location is structurally suited to bearing the weight of the IQ System Controller 2.
-  **NOTE:** During use, storage, and transport, keep the IQ System Controller 2:
 - Properly ventilated
 - Away from water, other liquids, heat, sparks, and direct sunlight
 - Away from excessive dust, corrosive and explosive gases, and oil smoke
 - Away from direct exposure to gas exhaust, such as from motor vehicles
 - Away from falling or moving objects, including motor vehicles. If mounted in the path of a motor vehicle, we recommend a 91cm (36-inch) minimum mounting height
 - In a location compliant with fire safety regulations
 - In a location compliant with local building codes and standards
-  **NOTE:** IQ System Controller 2 is not suitable for use as service equipment in Canada.



Environmental Protection

ELECTRONIC DEVICE: DO NOT THROW AWAY. Waste electrical products should not be disposed of with household waste. Refer to your local codes for disposal requirements.

IQSC-2-IG-0051-01-EN-US-2022-10-21

© 2022 Enphase Energy. All rights reserved. Enphase, the Enphase logo, IQ8 Microinverters, and other names are trademarks of Enphase Energy, Inc. Data subject to change.

